

## GV-TFD4700 4MP H.265 Super Low Lux WDR Pro IR Mini Fixed IP Dome



- 1/3" progressive scan super low lux CMOS
- Min. illumination at 0.01 lux
- Triple streams from H.265, H.264 or MJPEG
- Up to 30 fps at 2688 x 1520
- Intelligent IR
- Day and night function (with removable IR-cut filter)
- Wide Dynamic Range Pro (WDR Pro)
- IR distance up to 30 m (100 ft)
- Built-in micro SD card slot (SD / SDHC / SDXC / UHS-I, Class 10) for local storage
- 3-axis mechanism (pan / tilt / rotate)
- Two-way audio
- One sensor input and one alarm output
- DC 12V / PoE (IEEE 802.3af)
- Pigtail-free
- Defog
- 3D noise reduction
- Motion detection
- Text overlay
- Privacy mask
- Tampering Alarm
- Smart phone app support
- 12 languages supported
- ONVIF (Profile G, S, T) conformant

### Introduction

GV-TFD4700 is an indoor, fixed, network camera equipped with an automatic IR-cut filter and an IR LED for day and night surveillance. The camera supports H.265 video codec to achieve better compression ratio while maintaining high quality pictures at reduced network bandwidths. With the super low lux CMOS image sensor, the camera is capable of providing a color live view in near darkness.

### Dimensions

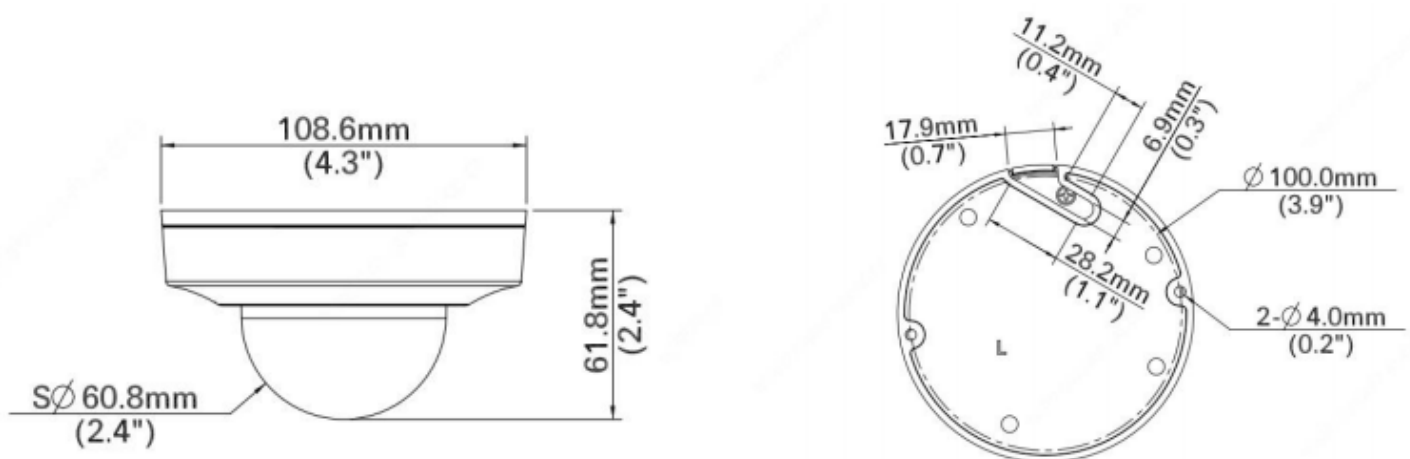

## Specifications

Camera		
Image Sensor		1/3" progressive scan super low lux CMOS
Picture Elements		2688 (H) x 1520 (V)
Minimum Illumination	Color	0.01 Lux (F2.0, AGC ON)
	IR ON	0 Lux
Shutter Speed		Auto / Manual (1 ~ 1/100000 sec)
White Balance		Auto / Manual
Gain Control		Auto / Manual
S/N Ratio		52 dB
WDR Pro		Yes
Dynamic Range		120 dB
Lens		
Megapixel		Yes
Day / Night		Yes (with removable IR-cut filter)
Lens Type		Fixed
Focal Length		2.8 mm
Maximum Aperture		F/2.0
Mount		M12
Horizontal FOV		95°
Operation	Focus	Fixed
	Zoom	Fixed
	Iris	Fixed
IR LED Quantity		1 IR LED
Max. IR Distance		30 m (100 ft)
Operation		
Video Compression		H.265, H.264, MJPEG
Video Streaming		Triple streams from H.265, H.264 or MJPEG
Video Resolution	Main Stream	2688 x 1520, 2560 x 1440 (Default), 2304 x 1296, 1920 x 1080
	Sub Stream	1280 x 720, 704 x 576, 704 x 288, 640 x 480, 640 x 360 (Default), 352 x 288
	Third Stream (Closed by Default)	640 x 360, 352 x 288
Frame Rate		30 fps at 2688 x 1520, 30 fps at 2560 x 1440, 30 fps at 1920 x 1080 (60 / 50 Hz) * The frame rate and performance may vary depending on the number of connections and data bitrates (different scenes).
Video Analytics		Motion Detection, Tampering Alarm, Audio Detection, Intrusion, Human Body Detection. *Tampering alarm, audio detection, Intrusion and Human Body Detection are only accessible through the camera's Web interface, which can be used to trigger alerts such as e-mail and FTP
Image Setting		Brightness, Contrast, Saturation, Sharpness, Flicker-less, 3D Noise Reduction, Image Orientation (Flip, Mirror, 0°, 180°), Exposure Mode, Shutter Speed, Gain Control, Slow Shutter, Backlight Compensation (BLC), Metering Control, D/N Sensitivity, WDR, Smart Illumination, White Balance, Defog
Audio Compression		G.711
Audio Support		Two-way Audio (external speaker required)
Digital I/O	Input	1 Input, dry contact, NO / NC
	Output	1 Relay Output (1A 30V DC / 0.3A 125V AC)
Network		
Interface		10/100 Ethernet
Protocol		ARP, DHCP, DDNS, DNS, DynDNS, FTP, HTTP, HTTPS, ICMP, IGMP, IPv4, NTP, PPPoE, RTCP, RTP, RTSP, SMTP, TCP, UDP, UPnP, ONVIF (Profile G, S, T)
Mechanical		
Temperature Detector		No
Camera Angle Adjustment	Pan	3° ~ 360°
	Tilt	0° ~ 68°
	Rotate	3° ~ 360°

Connectors	Power	2-pin terminal block (DC 12 V, 1.25 A), PoE
	Ethernet	RJ-45 connector
	Audio	1 in (built-in microphone) 4-pin terminal block pitch 2.5 mm (0.1") (Audio In & Audio Out)
	Digital I/O	4-pin terminal block pitch 2.5 mm (0.1")
	Local Storage	Micro SD card slot (SD / SDHC / SDXC / UHS-I, Class 10) *UHS-II card type is not supported.

#### General

Operating Temperature	-35°C ~ 60°C (-31°F ~ 140°F)
Humidity	0% ~ 95% (no condensation)
Power Source	12 V DC / PoE (IEEE802.3af)
Max. Power Consumption	5.5 W
Dimensions	∅ 108.6 x 61.8mm (∅4.28" x 2.43")
Weight	0.22 kg (0.49 lb)
Regulatory	FCC, CE, RoHS compliant

#### Web Interface

Installation Management	Web-based configuration
Maintenance	Firmware upgrade through Web Browser or GV-IP Device Utility
Access from Web Browser	Live View, Video Recording, Change Video Quality, Bandwidth Control, Image Snapshot, Defog, Text Overlay, Image Masking
Language	Czech, English, French, German, Hungarian, Italian, Japanese, Polish, Portuguese, Russian, Spanish, Traditional Chinese

#### Applications

Software Supported	GV-VMS (V17.4.1 / V18.2.1), GV-DVR / NVR (V8.9.1), GV-Control Center (V3.8.0), GV-Recording Server / Video Gateway (V2.0.0), GV-Edge Recording Manager Win version (V2.0.0), GV-Redundant / Failover Server (V1.2.0), GV-Mobile Server (V1.5.1)
Smart Device Access	GV-Eye for iOS and Android
Live Viewing	Browser (IE, Edge, Chrome, Firefox, Safari), Mobile App









#### Note:

1. It is required to apply patch files to some of the supported software.
2. Do not use clothes or any ordinary material to clean the camera cover since they may result in scratches.
3. Specifications are subject to change without notice.

#### Packing List

1. GV-TFD4700
2. Screw Kit
3. Drill Template Paster
4. Torx Wrench
5. 2-Pin Terminal Block
6. Download Guide
7. Warranty Guide

## Accessories

Model No.	Name		Details
GV-Mount107 (must be used with GV-Mount213)	Pendant Bracket		Dimensions: Ø 120 x 334 mm (Ø 4.72" x 13.15") Weight: 0.74 kg (1.63 lb)
GV-Mount211P	Wall Mount and Junction Box		Dimensions: Ø 233 x 125 x 125 mm (Ø 9.2" x 4.9" x 4.9") Weight: 1 kg (2.2 lb)
GV-Mount213	Wall / Ceiling Box Mount		Dimensions: Ø 109 x 39 mm (Ø 4.3" x 1.5") Weight: 0.2 kg (0.44 lb)
GV-Mount300-2	Convex Corner Mount		Dimensions: 137 x 233 x 160 mm (5.4" x 9.17" x 6.3") Weight: 1.65 kg (3.64 lb)
GV-Mount310-2	Concave Corner Mount		Dimensions: 111.2 x 369.9 x 210 mm (2.6" x 11.4" x 6.6") Weight: 1.65 kg (3.64 lb)
GV-Mount420 (must be used with GV-Mount211P)	Pole Mount Bracket		Dimensions: Ø 120 x 120 x 53.4 mm (Ø 4.7" x 4.7" x 2.1") Weight: 0.45 kg (0.99 lb) Steel Strap Diameter: Ø 67 ~ 127 mm (Ø 2.6" ~ 5")
GV-Mount704 (must be used with GV-Mount107)	Extension Tube		Dimensions: Ø 3.5 x 10 or 20 or 30 or 50 cm (Ø 1.38 x 3.9 or 7.9 or 11.8 or 19.7") Weight: 225g or 360g or 500g or 780g (0.5 lb or 0.79 lb or 1.1 lb or 1.72 lb)
GV-PA191	Power over Ethernet (PoE) Adapter		The GV-PA191 is a Power over Ethernet (PoE) adapter designed to provide power to the IP device through a single Ethernet cable.
GV-POE Switch			The GV-POE Switch is designed to provide power along with network connection for IP devices. The GV-POE Switch is available in various models with different numbers and types of ports.
Power Adapter			Contact our sales representatives for the countries and areas supported.